

Analog Devices Welcomes Hittite Microwave Corporation

NO CONTENT ON THE ATTACHED DOCUMENT HAS CHANGED



THIS PAGE INTENTIONALLY LEFT BLANK

Typical Applications

The HMC735LP5(E) is ideal for:

- Point-to-Point/Multi-Point Radio
- Test Equipment & Industrial Controls
- SATCOM
- Military End-Use

Features

Dual Output: $F_o = 10.5 - 12.2 \text{ GHz}$
 $F_o/4 = 2.625 - 3.05 \text{ GHz}$

Pout: +17 dBm

Phase Noise: -100 dBc/Hz @ 100 kHz Typ.

No External Resonator Needed

32 Lead 5x5mm SMT Package: 25mm²

Functional Diagram

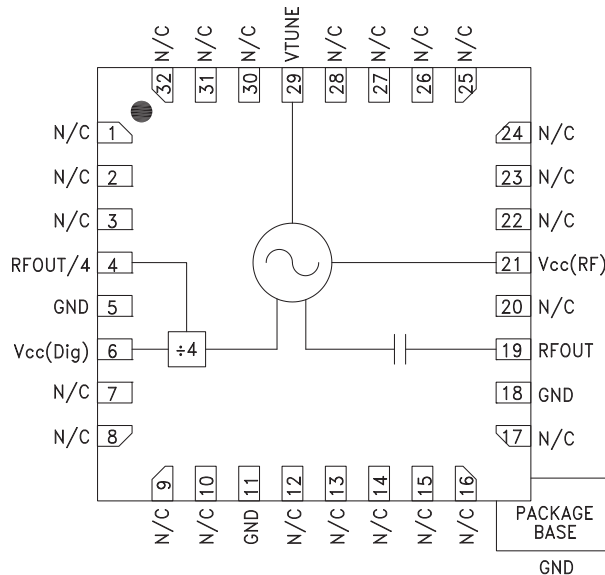

General Description

The HMC735LP5(E) is a GaAs InGaP Heterojunction Bipolar Transistor (HBT) MMIC VCO. The HMC735LP5(E) integrates resonators, negative resistance devices, varactor diodes and features a divide-by-4 frequency output. The VCO's phase noise performance is excellent over temperature, shock, and process due to the oscillator's monolithic structure. Power output is +17 dBm typical from a +5V supply voltage. The prescaler function can be disabled to conserve current if not required. The voltage controlled oscillator is packaged in a leadless QFN 5x5 mm surface mount package, and requires no external matching components.

Electrical Specifications, $T_A = +25^\circ \text{ C}$, $V_{cc} \text{ (Dig)}$, $V_{cc} \text{ (Amp)}$, $V_{cc} \text{ (RF)} = +5\text{V}$

Parameter	Min.	Typ.	Max.	Units	
Frequency Range	F_o $F_o/4$	10.5 - 12.2 2.625 - 3.05		GHz GHz	
Power Output	RFOUT RFOUT/4	14 -8	21 -1	dBm dBm	
SSB Phase Noise @ 100 kHz Offset, Vtune= +5V @ RFOUT		-100		dBc/Hz	
Tune Voltage	Vtune	1	13	V	
Supply Current	$I_{cc}(\text{Dig}) + I_{cc}(\text{Amp}) + I_{cc}(\text{RF})$	180	217	240	mA
Tune Port Leakage Current (Vtune= 13V)			10	μA	
Output Return Loss		8		dB	
Harmonics/Subharmonics	1/2 2nd 3rd		-65 -18 -40	dBc dBc dBc	
Pulling (into a 2.0:1 VSWR)		50		MHz pp	
Pushing @ Vtune= 5V		30		MHz/V	
Frequency Drift Rate		1.4		MHz/ $^\circ\text{C}$	

Frequency vs. Tuning Voltage, Vcc = +5V

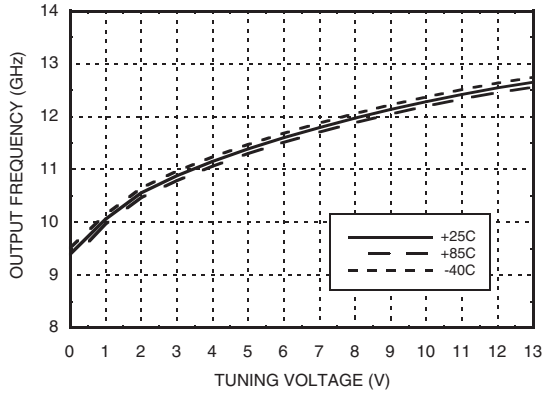

Frequency vs. Tuning Voltage, T= 25°C

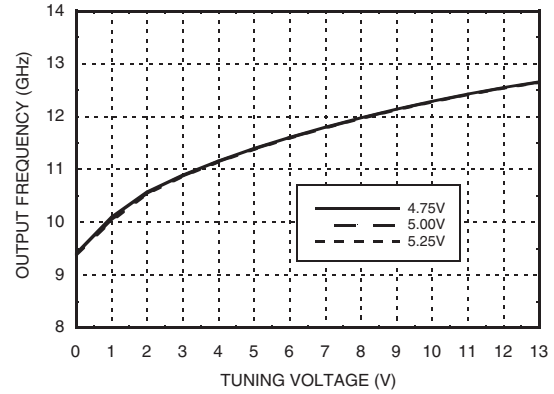

Sensitivity vs. Tuning Voltage, Vcc = +5V

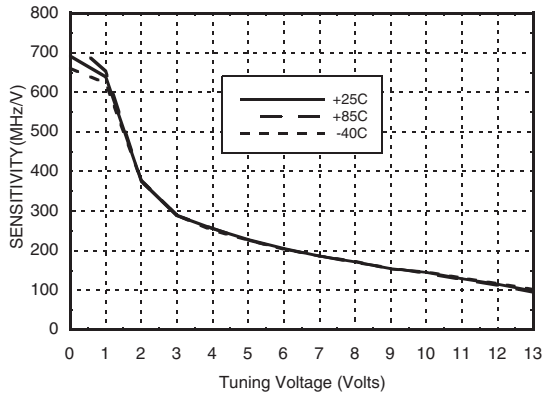

Output Power vs. Tuning Voltage, Vcc = +5V

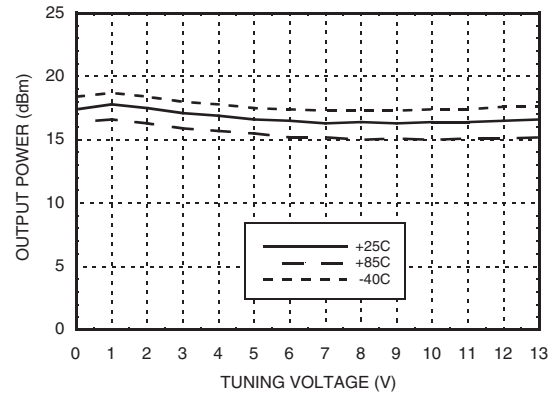

SSB Phase Noise vs. Tuning Voltage

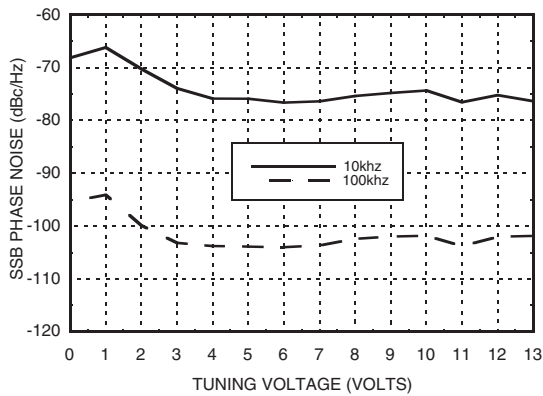

SSB Phase Noise @ Vtune = +5V

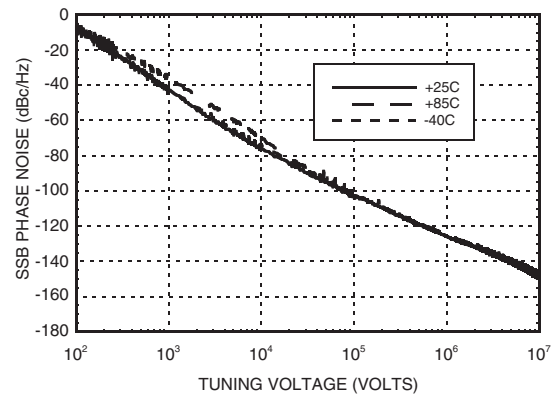

Divide-by-4 Frequency vs. Tuning Voltage, Vcc = +5V

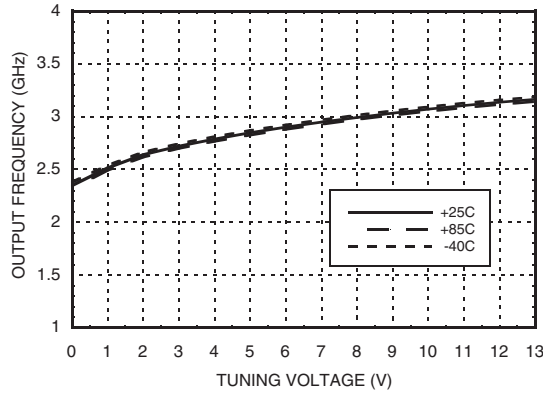

Divide-by-4 Output Power vs. Tuning Voltage, Vcc = +5V

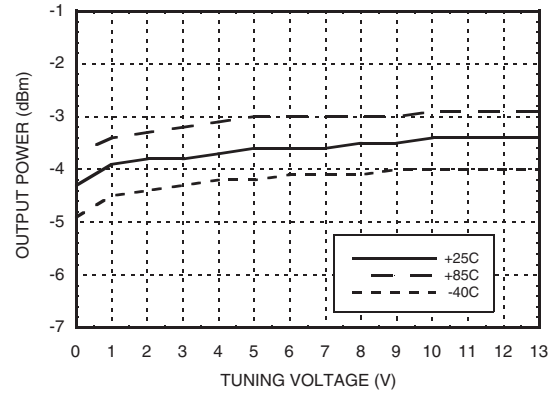

Outline Drawing

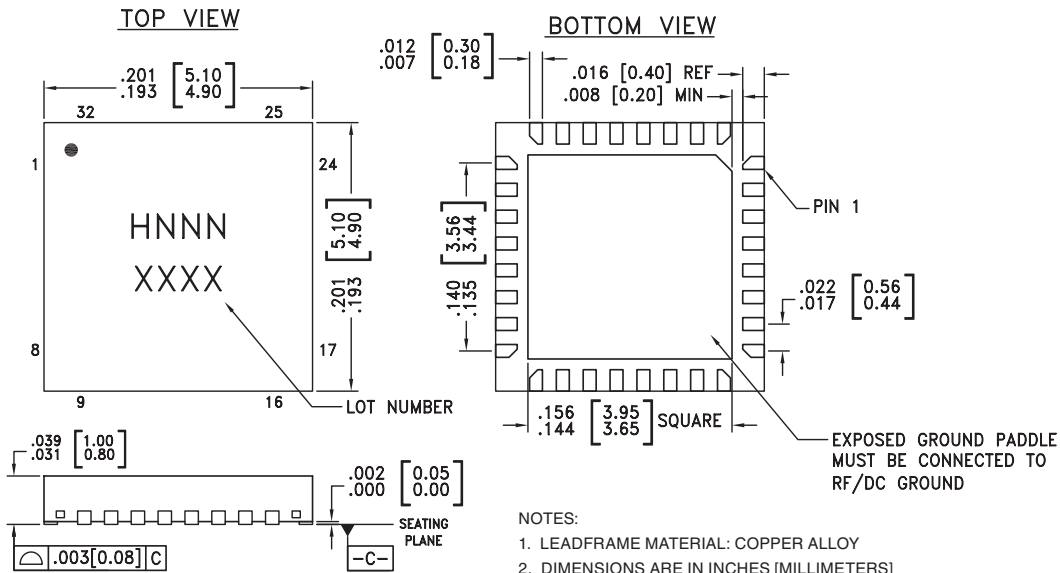

Package Information

Part Number	Package Body Material	Lead Finish	MSL Rating	Package Marking ^[3]
HMC735LP5	Low Stress Injection Molded Plastic	Sn/Pb Solder	MSL3 ^[1]	H735 XXXX
HMC735LP5E	RoHS-compliant Low Stress Injection Molded Plastic	100% matte Sn	MSL3 ^[2]	H735 XXXX

[1] Max peak reflow temperature of 235 °C

[2] Max peak reflow temperature of 260 °C

[3] 4-Digit lot number XXXX

Absolute Maximum Ratings

Vcc(Dig), Vcc(Amp), Vcc(RF)	+5.5 Vdc
Vtune	0 to +15V
Junction Temperature	135 °C
Continuous P _{diss} (T=85 °C) (derate 25.3 mW/C above 85 °C)	1.3 W
Thermal Resistance (junction to ground paddle)	39.5 °C/W
Storage Temperature	-65 to +150 °C
Operating Temperature	-40 to +85 °C

Typical Supply Current vs. Vcc



Vcc (V)	I _{cc} (mA)
4.75	197
5.00	217
5.25	237

Note: VCO will operate over full voltage range shown above.

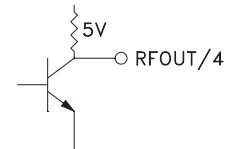
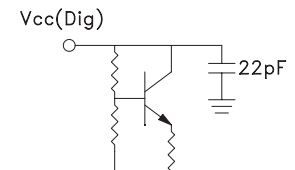
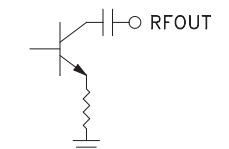
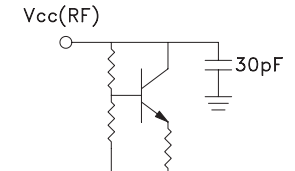
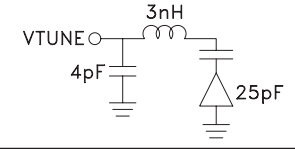

**ELECTROSTATIC SENSITIVE DEVICE
OBSERVE HANDLING PRECAUTIONS**

Pin Descriptions

Pin Number	Function	Description	Interface Schematic
1 - 3, 7 - 10, 12 - 17, 20, 22 - 28, 30 - 32	N/C	No Connection. These pins may be connected to RF/DC ground. Performance will not be affected.	
4	RFOUT/4	Divide-by-4 output. DC block required.	
6	Vcc (Dig)	Supply voltage for prescaler. If prescaler is not required, this pin may be left open to conserve approximately 100 mA of current.	
19	RFOUT	RF output (AC coupled).	
21	Vcc (RF)	Supply Voltage, +5V	
29	VTUNE	Control voltage and modulation input. Modulation bandwidth dependent on drive source impedance. See "Determining the FM Bandwidth of a Wideband Varactor Tuned VCO" application note.	
5, 11, 18, Paddle	GND	Package bottom has an exposed metal paddle that must be connected to RF/DC ground.	

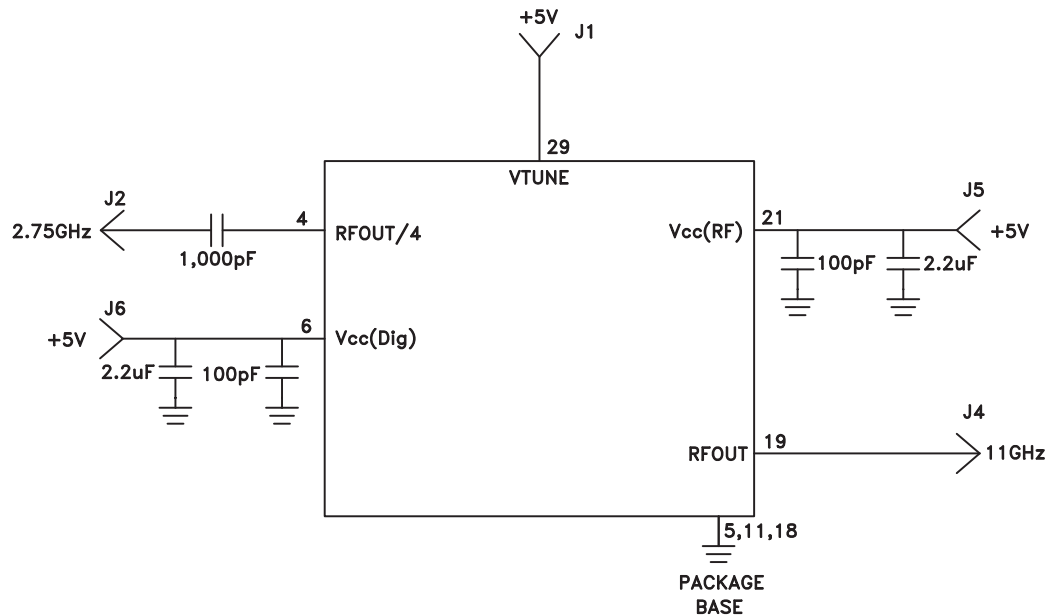
Application Circuit

Evaluation PCB

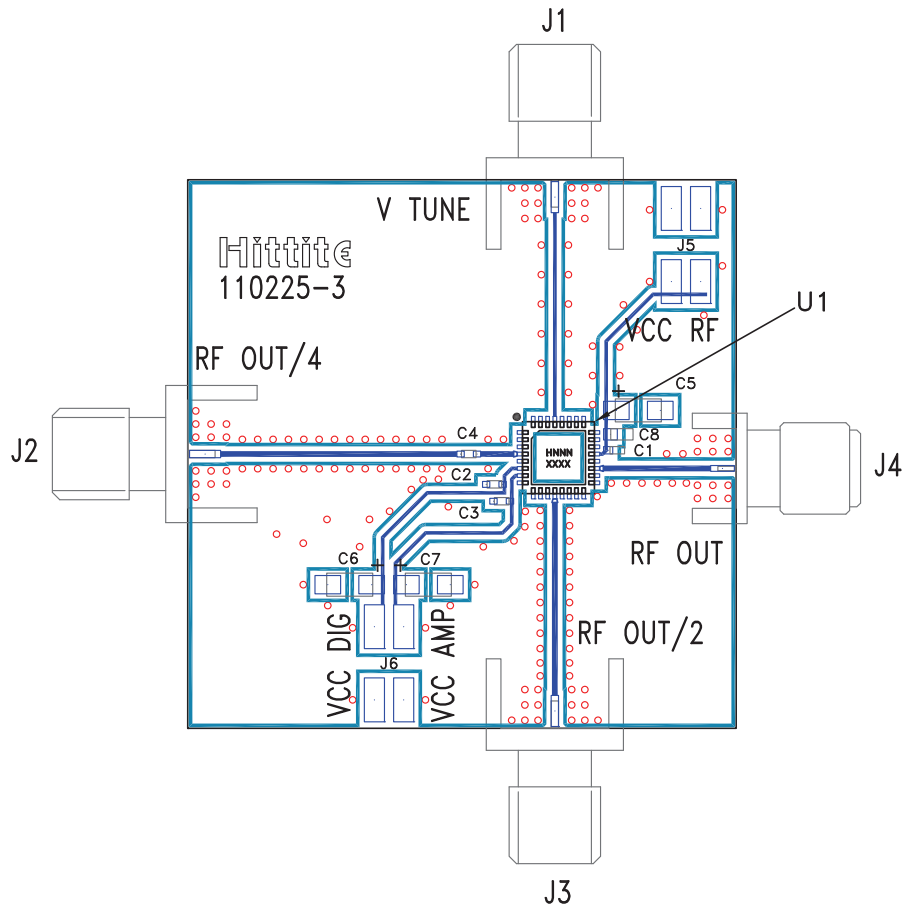

List of Materials for Evaluation PCB 110227 [1]

Item	Description
J1 - J4	PCB Mount SMA RF Connector
J5 - J6	2 mm DC Header
C1 - C3	100 pF Capacitor, 0402 Pkg.
C4	1,000 pF Capacitor, 0402 Pkg.
C5 - C7	2.2 μF Tantalum Capacitor
U1	HMC735LP5(E) VCO
PCB [2]	110225 Eval Board

[1] Reference this number when ordering complete evaluation PCB

[2] Circuit Board Material: Rogers 4350 or Arlon 25FR

The circuit board used in the application should use RF circuit design techniques. Signal lines should have 50 Ohm impedance while the package ground leads and backside ground paddle should be connected directly to the ground plane similar to that shown. A sufficient number of via holes should be used to connect the top and bottom ground planes. The evaluation circuit board shown is available from Hittite upon request.